

IRF7379PbF

HEXFET® Power MOSFET

- Generation V Technology
- Ultra Low On-Resistance
- Complimentary Half Bridge
- Surface Mount
- Fully Avalanche Rated
- Lead-Free

Description

Fifth Generation HEXFETs from International Rectifier utilize advanced processing techniques to achieve extremely low on-resistance per silicon area. This benefit, combined with the fast switching speed and ruggedized device design that HEXFET Power MOSFETs are well known for, provides the designer with an extremely efficient and reliable device for use in a wide variety of applications.

The SO-8 has been modified through a customized leadframe for enhanced thermal characteristics and multiple-die capability making it ideal in a variety of power applications. With these improvements, multiple devices can be used in an application with dramatically reduced board space. The package is designed for vapor phase, infra red, or wave soldering techniques.

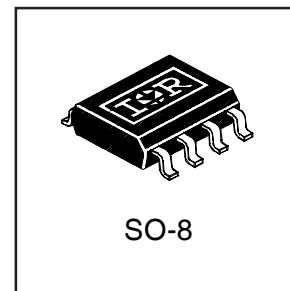
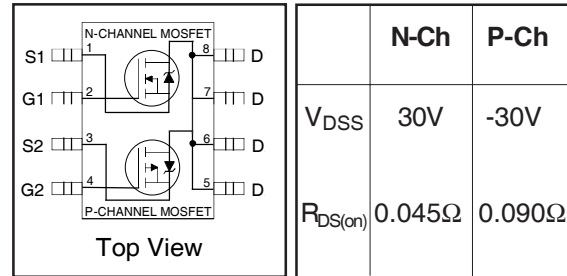

Absolute Maximum Ratings

| | Parameter | Max. | | Units |
|--------------------------------|---|--------------|-----------|-------|
| | | N-Channel | P-Channel | |
| V_{SD} | Drain-to-Source Voltage | 30 | -30 | A |
| $I_D @ T_A = 25^\circ\text{C}$ | Continuous Drain Current, $V_{GS} @ 10\text{V}$ | 5.8 | -4.3 | |
| $I_D @ T_A = 70^\circ\text{C}$ | Continuous Drain Current, $V_{GS} @ 10\text{V}$ | 4.6 | -3.4 | |
| I_{DM} | Pulsed Drain Current ① | 46 | -34 | |
| $P_D @ T_A = 25^\circ\text{C}$ | Power Dissipation | 2.5 | | W |
| | Linear Derating Factor | 0.02 | | W/°C |
| V_{GS} | Gate-to-Source Voltage | ± 20 | | V |
| dv/dt | Peak Diode Recovery dv/dt ② | 5.0 | -5.0 | V/ns |
| T_J, T_{STG} | Junction and Storage Temperature Range | -55 to + 150 | | °C |

Thermal Resistance Ratings

| | Parameter | Max. | Units |
|-----------------|------------------------------|------|-------|
| $R_{\theta JA}$ | Maximum Junction-to-Ambient③ | 50 | °C/W |

www.irf.com

1

Electrical Characteristics @ T_J = 25°C (unless otherwise specified)

| Parameter | Parameter | | Min. | Typ. | Max. | Units | Conditions |
|--|--------------------------------------|------|------|--------|-------|-------|--|
| | | | | | | | |
| V _{(BR)DSS} | Drain-to-Source Breakdown Voltage | N-Ch | 30 | — | — | V | V _{GS} = 0V, I _D = 250μA |
| | | P-Ch | -30 | — | — | | V _{GS} = 0V, I _D = -250μA |
| ΔV _{(BR)DSS} /ΔT _J | Breakdown Voltage Temp. Coefficient | N-Ch | — | 0.032 | — | V/°C | Reference to 25°C, I _D = 1mA |
| | | P-Ch | — | -0.037 | — | | Reference to 25°C, I _D = -1mA |
| R _{DS(ON)} | Static Drain-to-Source On-Resistance | N-Ch | — | 0.038 | 0.045 | Ω | V _{GS} = 10V, I _D = 5.8A ③ |
| | | | — | 0.055 | 0.075 | | V _{GS} = 4.5V, I _D = 4.9A ③ |
| | | P-Ch | — | 0.070 | 0.090 | | V _{GS} = -10V, I _D = -4.3A ③ |
| | | | — | 0.130 | 0.180 | | V _{GS} = -4.5V, I _D = -3.7A ③ |
| V _{GS(th)} | Gate Threshold Voltage | N-Ch | 1.0 | — | — | V | V _{DS} = V _{GS} , I _D = 250μA |
| | | P-Ch | -1.0 | — | — | | V _{DS} = V _{GS} , I _D = -250μA |
| g _{fs} | Forward Transconductance | N-Ch | 5.2 | — | — | S | V _{DS} = 15V, I _D = 2.4A ③ |
| | | P-Ch | 2.5 | — | — | | V _{DS} = -24V, I _D = -1.8A ③ |
| I _{DSS} | Drain-to-Source Leakage Current | N-Ch | — | — | 1.0 | μA | V _{DS} = 24V, V _{GS} = 0V |
| | | P-Ch | — | — | -1.0 | | V _{DS} = -24V, V _{GS} = 0V |
| | | N-Ch | — | — | 25 | | V _{DS} = 24V, V _{GS} = 0V, T _J = 125°C |
| | | P-Ch | — | — | -25 | | V _{DS} = -24V, V _{GS} = 0V, T _J = 125°C |
| I _{GSS} | Gate-to-Source Forward Leakage | N-P | — | — | ±100 | μA | V _{GS} = ±20V |
| Q _g | Total Gate Charge | N-Ch | — | — | 25 | nC | N-Channel I _D = 2.4A, V _{DS} = 24V, V _{GS} = 10V ③ |
| | | P-Ch | — | — | 25 | | |
| Q _{gs} | Gate-to-Source Charge | N-Ch | — | — | 2.9 | nC | ③ |
| | | P-Ch | — | — | 2.9 | | |
| Q _{gd} | Gate-to-Drain ("Miller") Charge | N-Ch | — | — | 7.9 | nC | P-Channel I _D = -1.8A, V _{DS} = -24V, V _{GS} = -10V |
| | | P-Ch | — | — | 9.0 | | |
| t _{d(on)} | Turn-On Delay Time | N-Ch | — | 6.8 | — | ns | N-Channel V _{DD} = 15V, I _D = 2.4A, R _G = 6.0Ω, R _D = 6.2Ω ③ |
| | | P-Ch | — | 11 | — | | |
| t _r | Rise Time | N-Ch | — | 21 | — | ns | ③ |
| | | P-Ch | — | 17 | — | | |
| t _{d(off)} | Turn-Off Delay Time | N-Ch | — | 22 | — | ns | P-Channel V _{DD} = -15V, I _D = -1.8A, R _G = 6.0Ω, R _D = 8.2Ω ③ |
| | | P-Ch | — | 25 | — | | |
| t _f | Fall Time | N-Ch | — | 7.7 | — | ns | ③ |
| | | P-Ch | — | 18 | — | | |
| L _D | Internal Drain Inductance | N-P | — | 4.0 | — | nH | Between lead, 6mm (0.25in.) from package and center of die contact |
| L _S | Internal Source Inductance | N-P | — | 6.0 | — | | |
| C _{iss} | Input Capacitance | N-Ch | — | 520 | — | pF | N-Channel V _{GS} = 0V, V _{DS} = 25V, f = 1.0MHz ③ |
| | | P-Ch | — | 440 | — | | |
| C _{oss} | Output Capacitance | N-Ch | — | 180 | — | pF | ③ |
| | | P-Ch | — | 200 | — | | |
| C _{rss} | Reverse Transfer Capacitance | N-Ch | — | 72 | — | pF | P-Channel V _{GS} = 0V, V _{DS} = -25V, f = 1.0MHz |
| | | P-Ch | — | 93 | — | | |

Source-Drain Ratings and Characteristics

| Parameter | Parameter | | Min. | Typ. | Max. | Units | Conditions |
|-----------------|--|------|------|------|------|-------|--|
| I _S | Continuous Source Current (Body Diode) | N-Ch | — | — | 3.1 | A | |
| | | P-Ch | — | — | -3.1 | | |
| I _{SM} | Pulsed Source Current (Body Diode) ① | N-Ch | — | — | 46 | A | |
| | | P-Ch | — | — | -34 | | |
| V _{SD} | Diode Forward Voltage | N-Ch | — | — | 1.0 | V | T _J = 25°C, I _S = 1.8A, V _{GS} = 0V ③ |
| | | P-Ch | — | — | -1.0 | | T _J = 25°C, I _S = -1.8A, V _{GS} = 0V ③ |
| t _{rr} | Reverse Recovery Time | N-Ch | — | 47 | 71 | ns | N-Channel T _J = 25°C, I _F = 2.4A, di/dt = 100A/μs ③ |
| P-Ch | — | 53 | 80 | | | | |
| Q _{rr} | Reverse Recovery Charge | N-Ch | — | 56 | 84 | nC | ③ |
| | | P-Ch | — | 66 | 99 | | |

Notes:

- ① Repetitive rating; pulse width limited by max. junction temperature. (See fig. 10)
- ② N-Channel I_{SD} ≤ 2.4A, di/dt ≤ 73A/μs, V_{DD} ≤ V_{(BR)DSS}, T_J ≤ 150°C
P-Channel I_{SD} ≤ -1.8A, di/dt ≤ 90A/μs, V_{DD} ≤ V_{(BR)DSS}, T_J ≤ 150°C
- ③ Pulse width ≤ 300μs; duty cycle ≤ 2%.
- ④ Surface mounted on FR-4 board, t ≤ 10sec.

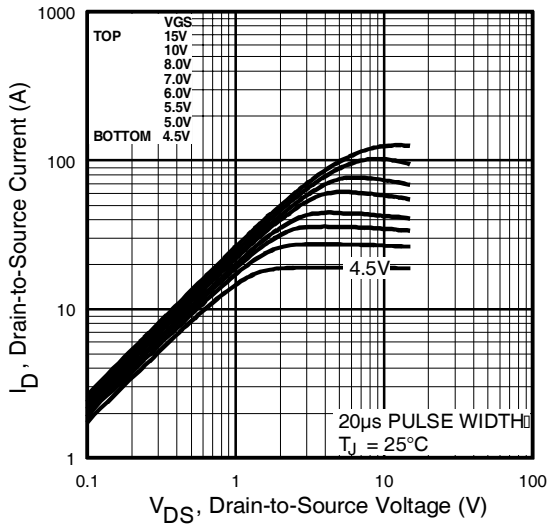

Fig 1. Typical Output Characteristics

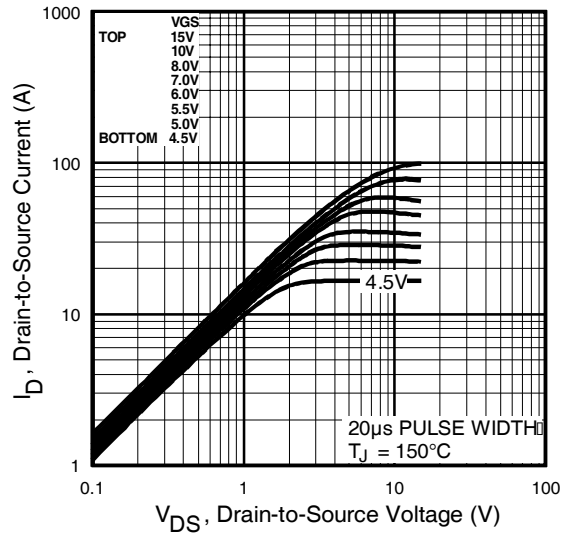

Fig 2. Typical Output Characteristics

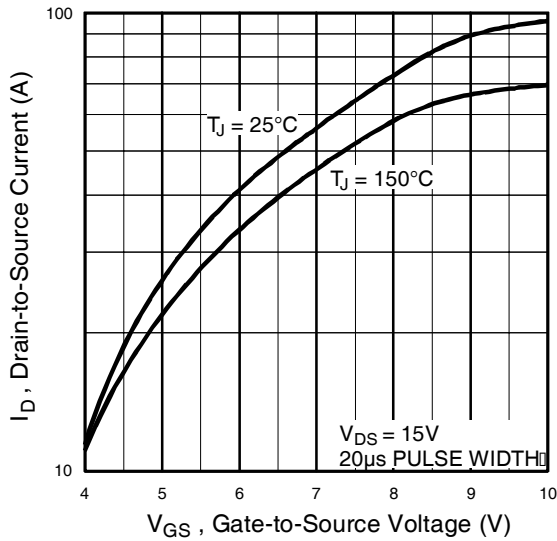

Fig 3. Typical Transfer Characteristics

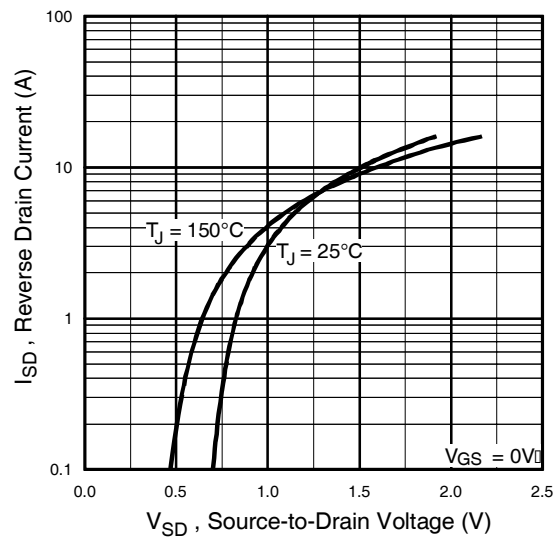

Fig 4. Typical Source-Drain Diode Forward Voltage

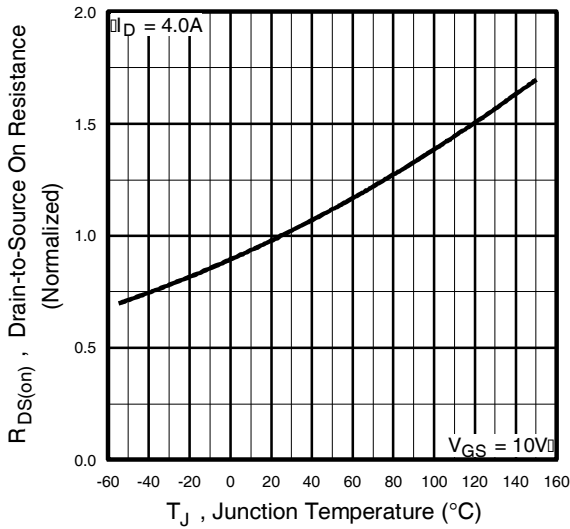

Fig 5. Normalized On-Resistance Vs. Temperature

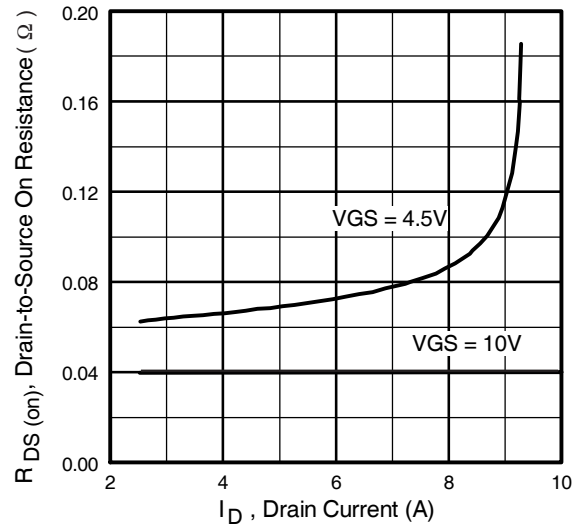

Fig 6. Typical On-Resistance Vs. Drain Current

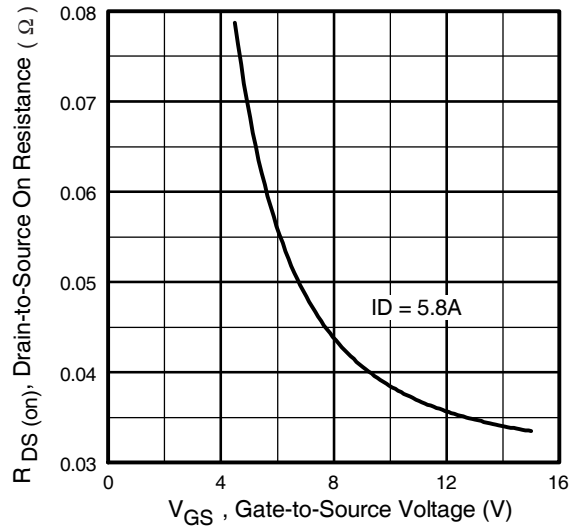

Fig 7. Typical On-Resistance Vs. Gate Voltage

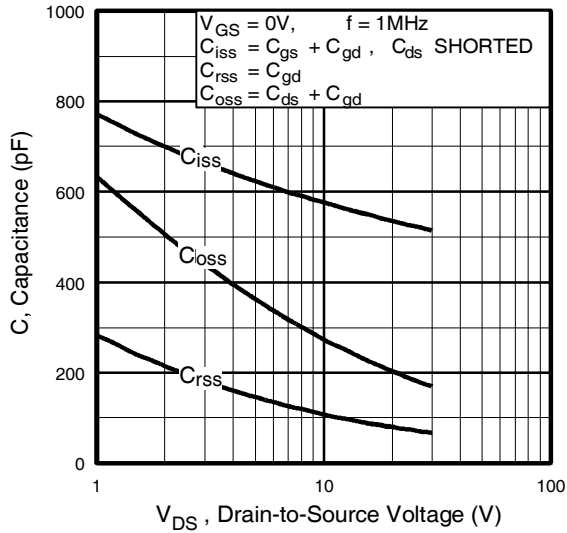

Fig 8. Typical Capacitance Vs. Drain-to-Source Voltage

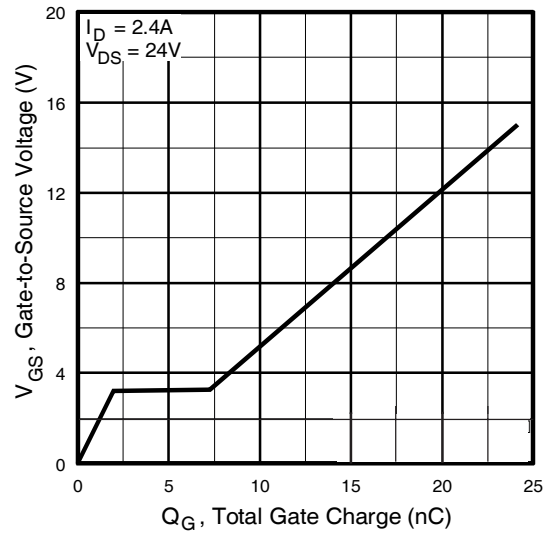

Fig 9. Typical Gate Charge Vs. Gate-to-Source Voltage

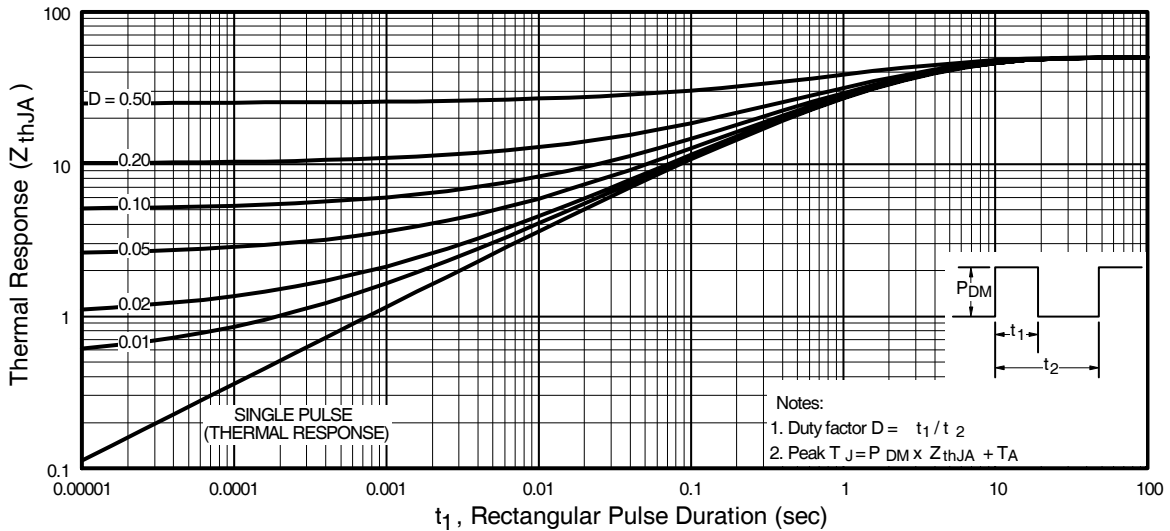

Fig 10. Maximum Effective Transient Thermal Impedance, Junction-to-Ambient

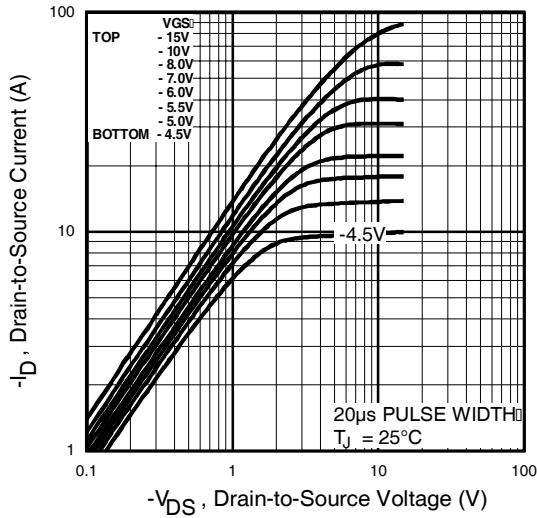

Fig 11. Typical Output Characteristics

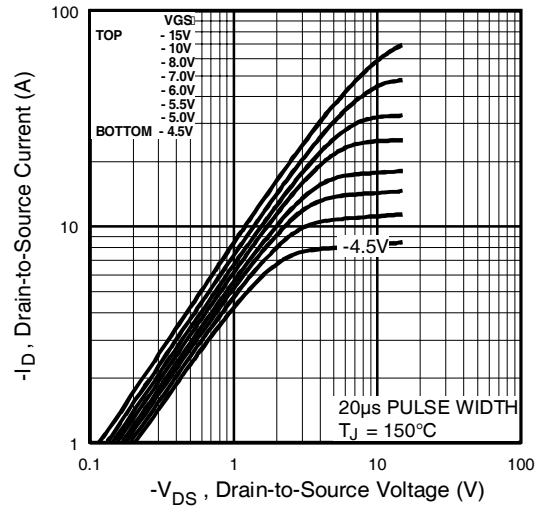

Fig 12. Typical Output Characteristics

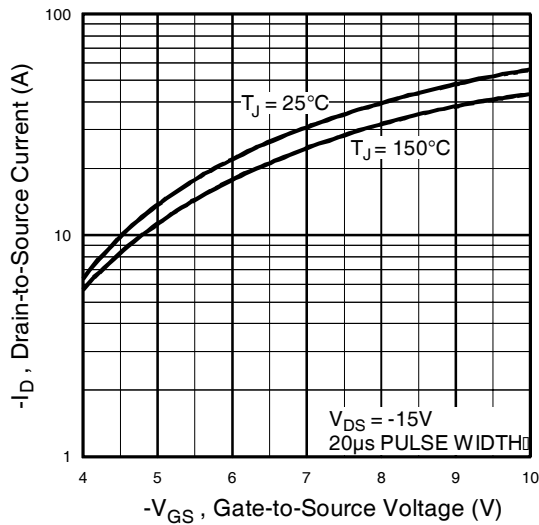

Fig 13. Typical Transfer Characteristics

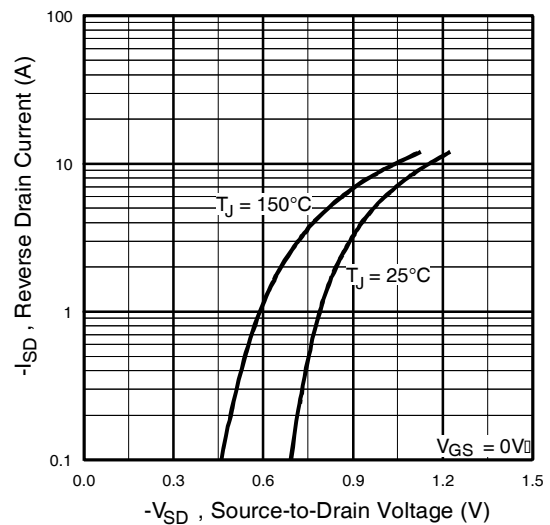

Fig 14. Typical Source-Drain Diode Forward Voltage

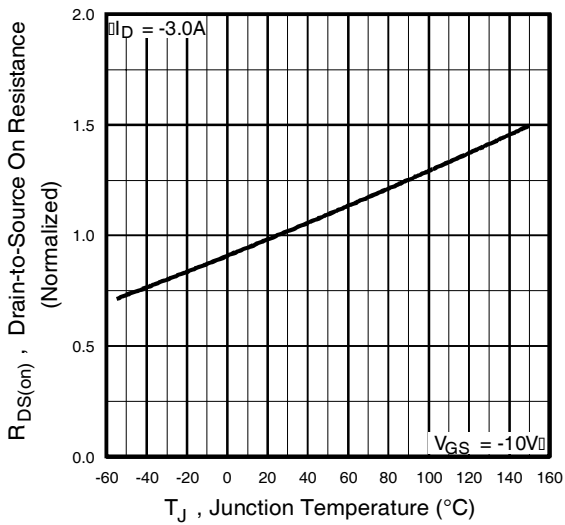

Fig 15. Normalized On-Resistance Vs. Temperature

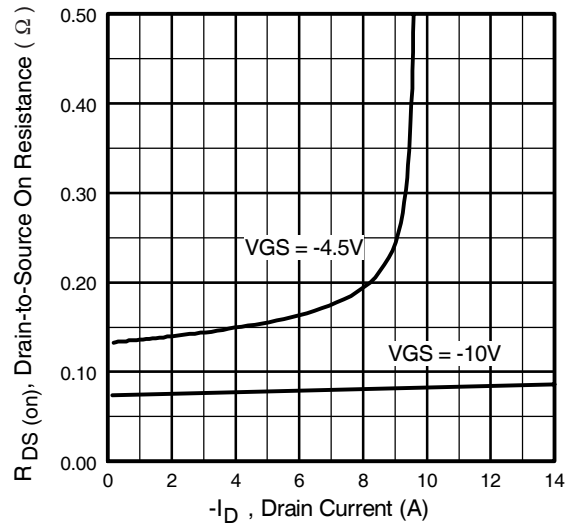

Fig 16. Typical On-Resistance Vs. Drain Current

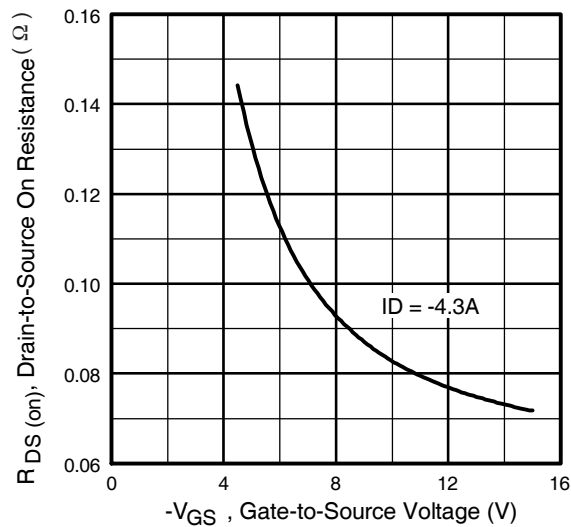

Fig 17. Typical On-Resistance Vs. Gate Voltage

IRF7379PbF

P-Channel

International
IR Rectifier

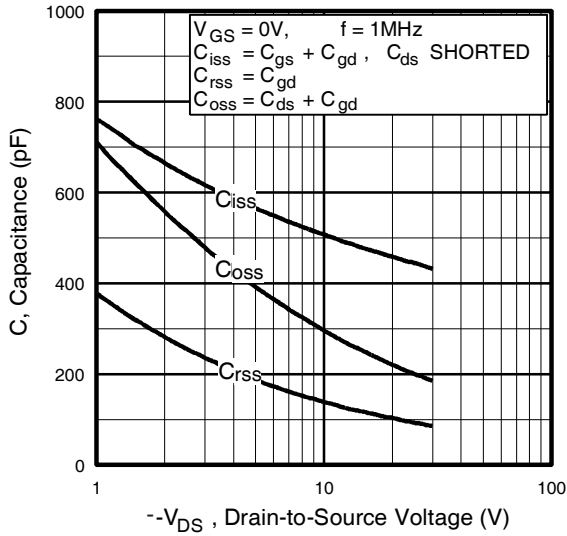

Fig 18. Typical Capacitance Vs. Drain-to-Source Voltage

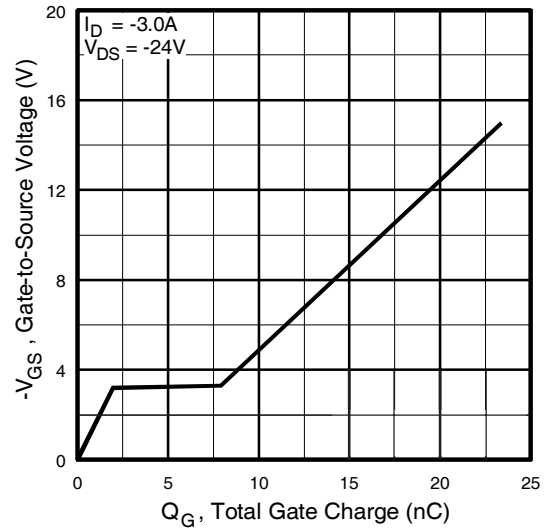

Fig 19. Typical Gate Charge Vs. Gate-to-Source Voltage

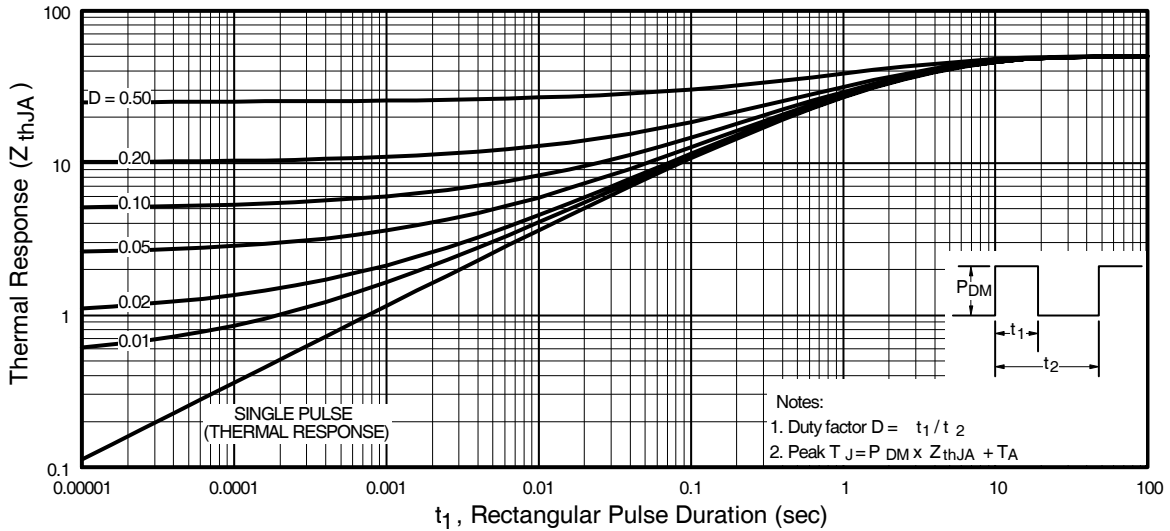
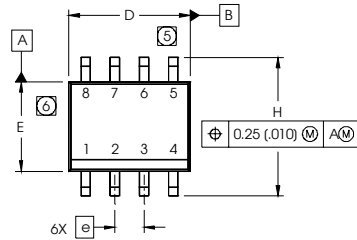

Fig 20. Maximum Effective Transient Thermal Impedance, Junction-to-Ambient

SO-8 Package Outline

Dimensions are shown in millimeters (inches)



| DIM | INCHES | | MILLIMETERS | |
|-----|------------|-------|-------------|------|
| | MIN | MAX | MIN | MAX |
| A | .0532 | .0688 | 1.35 | 1.75 |
| A1 | .0040 | .0098 | 0.10 | 0.25 |
| b | .013 | .020 | 0.33 | 0.51 |
| c | .0075 | .0098 | 0.19 | 0.25 |
| D | .189 | .1968 | 4.80 | 5.00 |
| E | .1497 | .1574 | 3.80 | 4.00 |
| e | .050 BASIC | | 1.27 BASIC | |
| e1 | .025 BASIC | | 0.635 BASIC | |
| H | .2284 | .2440 | 5.80 | 6.20 |
| K | .0099 | .0196 | 0.25 | 0.50 |
| L | .016 | .050 | 0.40 | 1.27 |
| y | 0° | 8° | 0° | 8° |

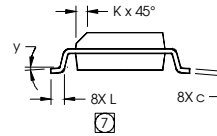
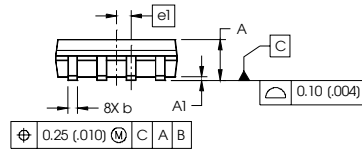

- NOTES:
1. DIMENSIONING & TOLERANCING PER ASME Y14.5M-1994.
 2. CONTROLLING DIMENSION: MILLIMETER
 3. DIMENSIONS ARE SHOWN IN MILLIMETERS (INCHES).
 4. OUTLINE CONFORMS TO JEDEC OUTLINE MS-012AA.
 - ⑤ DIMENSION DOES NOT INCLUDE MOLD PROTRUSIONS. MOLD PROTRUSIONS NOT TO EXCEED 0.15 (.006).
 - ⑥ DIMENSION DOES NOT INCLUDE MOLD PROTRUSIONS. MOLD PROTRUSIONS NOT TO EXCEED 0.25 (.010).
 - ⑦ DIMENSION IS THE LENGTH OF LEAD FOR SOLDERING TO A SUBSTRATE.

FOOTPRINT

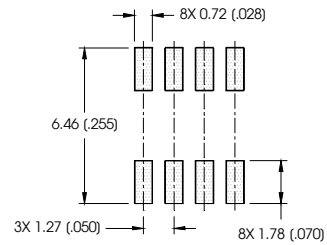

SO-8 Part Marking Information (Lead-Free)

EXAMPLE: THIS IS AN IRF7101 (MOSFET)

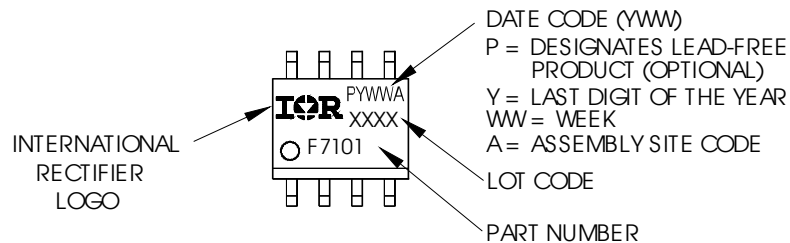

SO-8 Tape and Reel

Dimensions are shown in millimeters (inches)

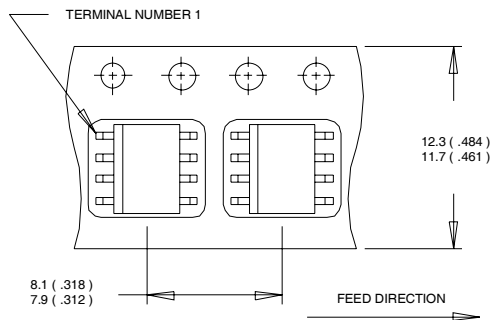

NOTES:

1. CONTROLLING DIMENSION : MILLIMETER.
2. ALL DIMENSIONS ARE SHOWN IN MILLIMETERS(INCHES).
3. OUTLINE CONFORMS TO EIA-481 & EIA-541.

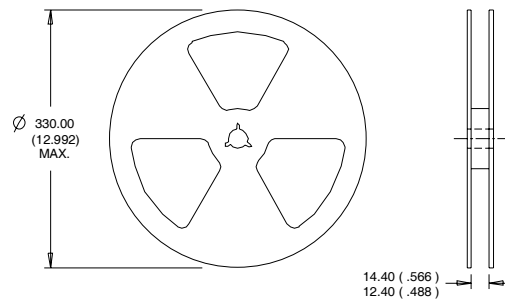

NOTES :

1. CONTROLLING DIMENSION : MILLIMETER.
2. OUTLINE CONFORMS TO EIA-481 & EIA-541.

Data and specifications subject to change without notice.
This product has been designed and qualified for the Consumer market.
Qualifications Standards can be found on IR's Web site.

International
IR Rectifier

IR WORLD HEADQUARTERS: 233 Kansas St., El Segundo, California 90245, USA Tel: (310) 252-7105
TAC Fax: (310) 252-7903

Visit us at www.irf.com for sales contact information.10/04

www.irf.com

Mouser Electronics

Authorized Distributor

Click to View Pricing, Inventory, Delivery & Lifecycle Information:

[Infineon:](#)

[IRF7379PBF](#)